

Impeccable Detail at Distance and in Any Conditions



Overview

Verkada's Bullet Series is designed to withstand harsh conditions and its visible form factor helps deter potential threats. There are two CB52 models: the CB52-E, which has a wide-angle field of view and the CB52-TE, which has a powerful zoom. Additionally, the cameras feature powerful long-range IR LEDs that enable them to produce clear images even at a distance of up to 50 meters at anytime of day.

Bullet cameras are designed for use in exposed outdoor environments. They are constructed with a robust aluminum unibody that encloses hermetically sealed internal electrical components. The camera's design includes a built-in pigtail connector that allows for easy insertion of an ethernet cable without needing to remove the outer body. The external housing offers IP67 protection against dust and heavy rain and IK10 protection against damage from vandals, hail and flying debris.

All 2nd generation Bullet cameras are outfitted with a cutting-edge system on a chip (SOC) which features a dedicated computer vision co-processor. Powered by Ambarella CV25 chipsets, these cameras can accurately capture license plates from vehicles traveling at speeds of up to 80mph / 128kph and do so simultaneously across three lanes. The Bullet Series is the single line of Verkada cameras that supports our License Plate Recognition feature, enabling users to capture and search for specific vehicles by their license plate numbers.

In addition, the Bullet Series has powerful edge processing capabilities that enable advanced computer vision features, including Verkada's People and Vehicle Analytics. These cameras also offer standard capabilities such as data encryption, onboard storage and motion detection, which help organizations rapidly scale their security coverage and enhance situational awareness across multiple locations.

Key features

Enterprise-grade performance

- High-resolution sensors up to 5MP
- License Plate Recognition available only on Bullet cameras
- Advanced edge processing for motion, people and vehicle analytics

Storage and processing

- 256GB-2TB of onboard storage
- Up to 365 days of retention in standard quality
- Low-bandwidth impact, only using 20-50 kbps per camera at rest

Certifications

- IP67 weather rating
- IK10 impact rating
- NDAA compliant



Verkada's hybrid cloud architecture



No NVR or DVRs

Industrial-grade onboard storage saves up to 365 days of continuous video¹

Easy to scale

Bandwidth friendly and supports thousands of cameras across unlimited locations

Centralized management

Modern platform enables secure access on any device from anywhere in the world

The Reliability of Onboard Storage, With the Accessibility of the Cloud

Simple to install

- No NVRs, DVRs, or servers—just a PoE connection
- Cameras come online and configure in minutes
- No added software or complexities like port forwarding

Easy to use

- Centralized management for secure remote access on any device nearly anywhere
- No training required to access footage and features
- Find, download and share footage from any device

Advantages of cloud-managed solution

- Real-time alerts if cameras fall offline
- SAML-based integration with single-sign on (SSO) solutions
- Continuous updates with new AI features
- Instantly share live footage via SMS and email
- Live, proactive alerting based on unusual activity

Ready for scale

- Bandwidth-friendly, operating at just 20–50 kbps
- Scale to thousands of cameras per location
- No added equipment needed to support additional cameras

No hidden costs

- Hardware includes an industry-leading 10-year warranty
- Automatic firmware updates keep systems secure
- New features and enhancements are added at no additional costs



1. All our cameras record in "adaptive quality," capturing both standard and high quality streams. Standard quality (SQ) video is stored up to the amount of retention specified by the customer. The amount of high quality video stored on the camera will depend on the amount of motion detected by the camera over time. To learn more, visit our website: <https://www.verkada.com/blog/recording-in-adaptive-quality/>



Verkada Command overview

All-in-one Cloud-based Management Software for Verkada Security Cameras

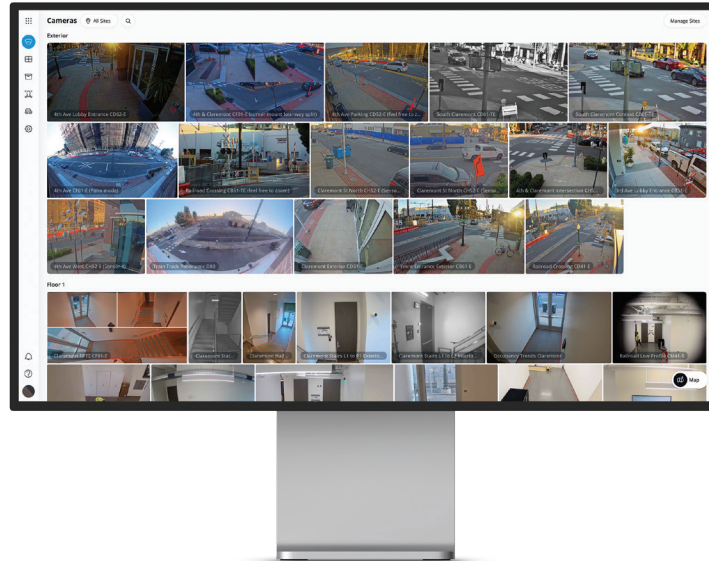

Command, Verkada’s cloud-based management software, is designed to deliver simple access and management for all cameras and users across all sites from virtually anywhere in the world. From Command, users can set up new cameras, create sites, manage settings, access live and archived footage, manage users and access the advanced features powered by Verkada’s edge-based analytics.

Manage from anywhere

- Remotely access footage and manage sites from any browser or device
- Native apps for iOS, Android and Verkada’s VX52 Viewing Station
- Receive alerts for offline cameras, tampering and motion detection

Effortlessly archive and share

- Command licenses include unlimited cloud archiving and 30-days of cloud backup
- Easily export any footage in a shareable MP4 format
- Share Live Links and floorplans with first responders

Scale with simplicity

- Add more devices and sites without complicating the user experience
- Leverage granular roles and permissions to manage users at scale
- Bring cameras online without 3rd party plugins, thick clients or downloads

Stay secure from the ground up

- Stay secure with data encrypted in transit (AES 128) and at rest (AES 256)
- Access cameras securely without port-forwarding, VPNs, or complicated configurations
- Receive automatic firmware updates to stay a step ahead of emerging threats

Quickly detect and respond to threats

- Stay informed with customizable, intelligent alerts
- Speed up investigations with intelligent people and face detection
- Search and filter to find vehicles of interest and detected license plates



Verkada's People Analytics

Simplify and Speed Up Investigations

With Intelligent People and Face Detection

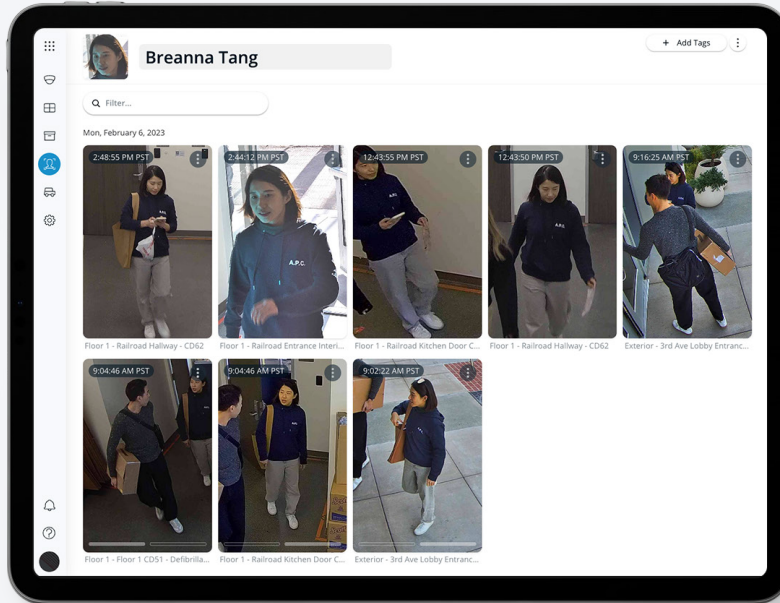

Available for all Verkada camera models, People Analytics combines intelligent edge-based video processing with computer vision in the cloud to give users high-quality images of all individuals identified in the scene. Using People Analytics, customers can filter people by various attributes and expedite investigations.

Bring Intelligence to Investigations

Face search

- Quickly search for matching people by selecting an existing face from your organization or by uploading an image

Person history

- Browse through high-resolution snapshots of people detected
- Save snapshots or easily access associated full-res video
- Search for matched people across your entire organization with cross-camera search

Attribute filters

- Filter based on a range of attributes, including clothing color, gender appearance and facial matches

Person of Interest notifications

- Set up proactive SMS/email notifications for alerting when a matching face is detected by a camera
- Create a Person of Interest by using an uploaded image or an existing face from your organization



Verkada's Vehicle Analytics Quickly Search and Filter To Find Vehicles of Interest

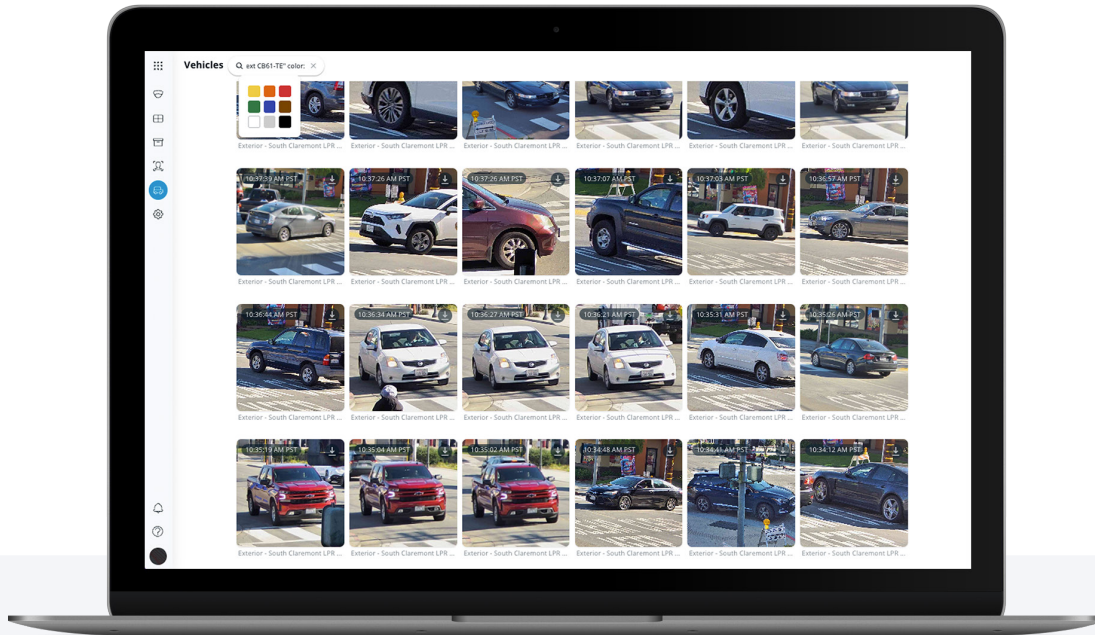

Vehicle Analytics is a powerful edge-based feature that gives users high-quality images of all vehicles identified in a scene. With Verkada's centralized management platform, customers can filter vehicles by date, time, color and body type.

Find and Filter Vehicles With Ease

Vehicle history

- Browse through high-resolution snapshots of vehicles detected in frame
- Save snapshots or easily access associated full-res video

Investigate anywhere

- Vehicle Analytics is available from any compatible device and can be accessed from virtually anywhere in the world

Cross-camera search

- Easily find similar vehicles of interest across all cameras deployed across all sites
- Create and export playback of multiple angles of a vehicle to quickly provide evidence

Attribute filters

- Filter based on a range of attributes, including vehicle color and body type



License Plate Recognition

Enhanced Vehicle Insights with Verkada's Powerful LPR Camera Solution

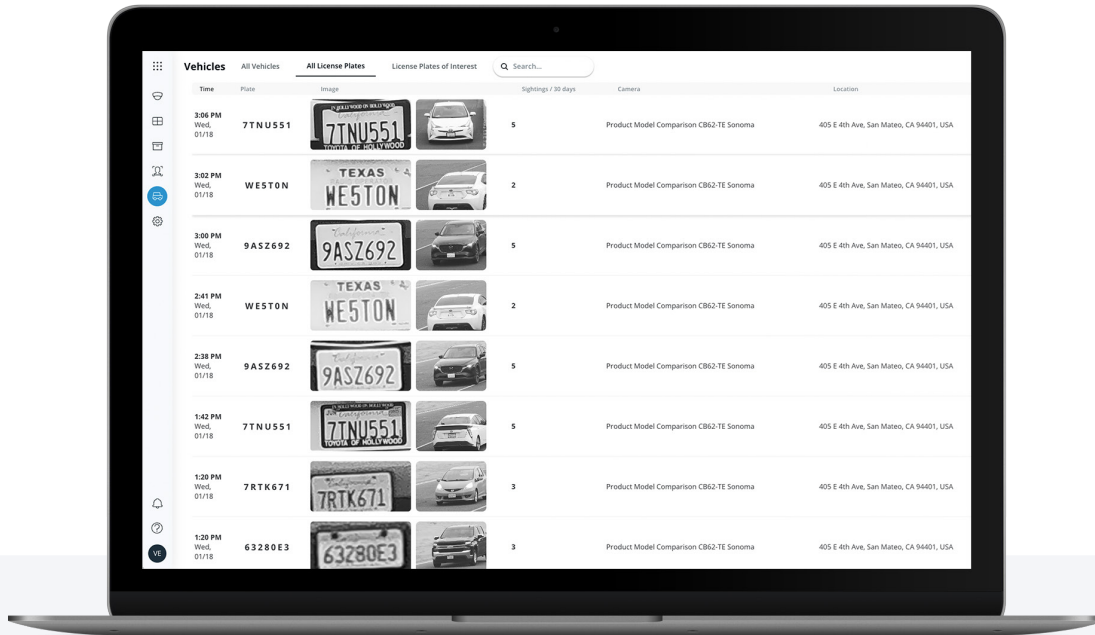

Verkada's License Plate Recognition (LPR) solution offers intelligent software that allows organizations to monitor license plates in real-time and streamline vehicle investigations. The solution uses Verkada's edge-based processing and computer vision technology to capture license plate images and provide users with a readable and searchable list of license plate numbers. These captures are connected to live or recorded video for added context.

Automatic License Plate Detection

Track fast-moving vehicles and broaden your coverage

Capture license plate characters at speeds of up to 80 mph / 128 kph, cover up to three lanes and recognize international license plates – all with high precision and nearly instant recall*

Maximize your video security capabilities with our LPR cameras

Retain key camera functionality in LPR mode. Easily conduct motion searches, review recorded history and archive footage

Streamline investigations with our user-friendly LPR system

Improve security and control access by adding custom descriptions to each license plate

Find License Plates - even with incorrect or incomplete input

Get more comprehensive search results with our system that provides approximate license plate matches even if the inputted characters are incorrect or if the system is unable to capture all characters

Receive custom License Plate of Interest Alerts

Send alerts to specific individuals or entire teams when designated license plates are detected across your LPR-enabled cameras

*For best results, install cameras as outlined in the [User Guide for License Plate Recognition](#).



Verkada's Bullet Series hardware

Designed and Constructed With the Highest Level of Precision and Quality

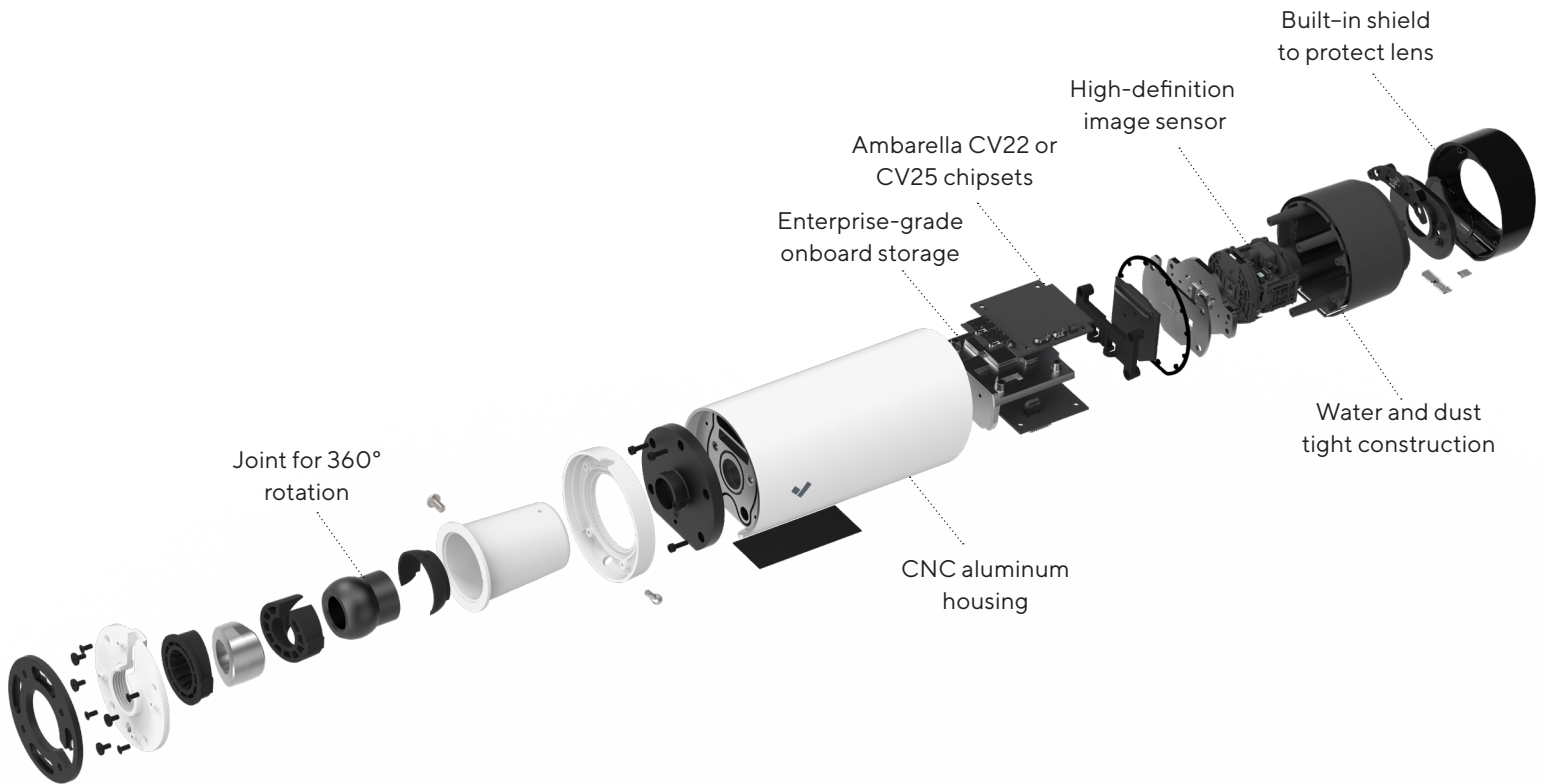

Protective housing

- Durable CNC aluminum housing able to withstand impacts up to IK10 rating
- Water and dust tight construction with IP67 rating to protect the lens assembly
- Built-in shield to protect lens from obstruction

High-performance hardware

- High-definition image sensor with 5MP ultra-HD resolution and 3x optical zoom
- Advanced processing capabilities with Ambarella CV22 or CV25 chipsets

System functionality

- Enterprise-grade onboard storage capacity for up to 365 days of standard quality footage
- Flexible installation with a rotating joint for 360° rotation



Comparison: wide angle and telephoto Lens Options for the Bullet Series

Wide Angle

Telephoto

Focal Length

2.8mm-8mm

8mm-20mm

Image at
No Zoom



CB52-E at 2.8mm

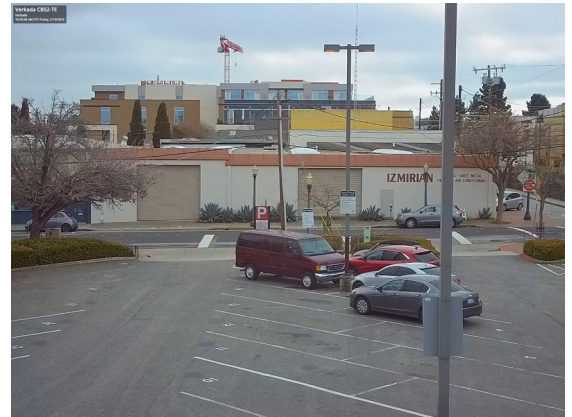

CB52-TE at 8mm

Image at
Full Zoom

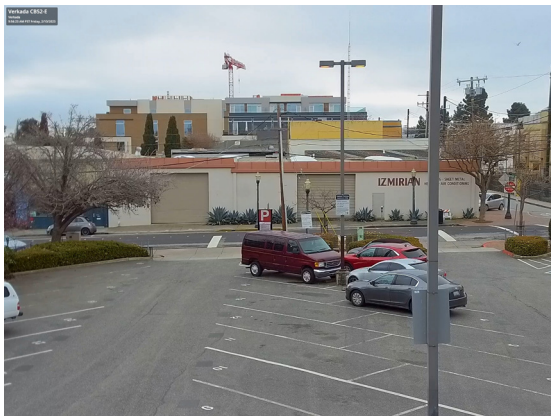

CB52-E at 8mm



CB52-TE at 20mm



Bullet Series Tech Specs



CB52-E

Camera features

Image Sensor	1/2.8" Progressive CMOS	Shutter Speed	1/30 sec. to 1/10,000 sec.
Sensor Resolution¹	5MP (2688 x 1944)	Day/Night	IR-cut filter for day and night function
Lens Type	Varifocal; motorized zoom	IR Cut Filter	Yes
Focal Length	2.8mm–8mm	IR Range	30m / 98ft
Aperture	F1.3–F2.4	Minimum Illumination	0.009 lux @ F1.9 (Color) 0 lux with IR Illuminators on
Iris	P-Iris	Onboard Storage	Capacity: From 256GB to 2TB Card: MicroSD, SDXC
Field of View (after LDC²)	Horizontal: 41° – 99° (39° – 95°) Vertical: 30° – 74° (30° – 74°) Diagonal: 50° – 125° (48° – 110°)	CPU	Ambarella CV25S88
Camera Movement	Tilt: 0° to 90° Pan: 360° Rotation: 360°		

Standard video settings

Compression	H.264	Historical Video Settings	Adaptive quality ¹
Frame Rate³	24fps	Video Streaming Settings	High quality (HQ) - 1,500 Kbps Standard quality (SQ) - 300 Kbps

Standard audio settings

Audio	Not supported
--------------	---------------

Power and network

Power Input⁴	With IR: IEEE 802.3at Type 2 PoE+ Without IR: IEEE 802.3af Type 1 PoE Extended temperature range: IEEE 802.3at Type 2 PoE+	Connectivity	RJ-45 cable connector for network/PoE connection; 10/100 Mbps
Power Consumption⁴	With IR: 37-57V, 0.38-0.25A, 14W Without IR: 37-57V, 0.09-0.06A, 3.46W Extended temperature range: 37-57V, 0.61-0.37A, 22.57W	RTSP	RTSP 1.0 RFC 2326 Max concurrent streams: 2 Audio support: No

1. All our cameras record in "adaptive quality," capturing both standard and high quality streams. Standard quality (SQ) video is stored up to the amount of retention specified by the customer. The amount of high quality video stored on the camera will depend on the amount of motion detected by the camera over time. To learn more, visit our website:

<https://www.verkada.com/blog/recording-in-adaptive-quality/>

2. Lens Distortion Correction (LDC) crops the sensor field of view to deliver a rectified, undistorted output image.

3. Frame rate can be adjusted by support.

4. In temperatures below -8.5°C / 16.7°F, a IEEE 802.3bt Type 3 PoE++ power source is required; even if IR is off.



Bullet Series Tech Specs



CB52-E

General

Operating Temperature	-40°C to 50°C / -40°F to 122°F	LED Indicator	System power and status indicator
Humidity	0 to 90%	Warranty	10 Years
Certifications	FCC, ICES, CE, UKCA, RCM, VCCI, BIS, UL/IEC62368-1, IP67 weather rating, IK10 impact rating, NDAA	Included Accessories	4x M4x8 screws, 4x TP4x30 mount screws, mount plate, junction box adapter, junction box cover, T25 hand tool

Mechanical

Weight	Camera: 1464g / 51.6oz Mount plate: 33g / 1.16oz	Body	Aluminum
Dimensions	Ø: 85mm / 3.35in L: 254mm / 10in		

Software capabilities

Alerts	Camera status, motion detection, people detection, vehicle detection, Person of Interest detection, crowd detection	Streaming and Storage	Cloud backup, configurable retention days, selectable storage location, low bandwidth mode, timelapse, RTSP
People Analytics	People search, attribute search, face search, Occupancy Trends	Sharing and Privacy	Live Link, privacy regions, audit log
Vehicle Analytics	Vehicle search, attribute search	License Plate Recognition	License Plate of Interest alerts, license plate indexing



Bullet Series Tech Specs



CB52-TE

Camera features

Image Sensor	1/2.8" Progressive CMOS	Shutter Speed	1/30 sec. to 1/10,000 sec.
Sensor Resolution¹	5MP (2688 x 1944)	Day/Night	IR-cut filter for day and night function
Lens Type	Varifocal; motorized zoom	IR Cut Filter	Yes
Focal Length	8mm–20mm	IR Range	50m / 164ft
Aperture	F1.5–F2.8	Minimum Illumination	0.009 lux @ F1.9 (Color) 0 lux with IR Illuminators on
Iris	P-Iris	Onboard Storage	Capacity: From 256GB to 2TB Card: MicroSD, SDXC
Field of View (after LDC²)	Horizontal: 16° – 38° (16° – 37°) Vertical: 12° – 28° (12° – 27°) Diagonal: 19° – 48° (19° – 44°)	CPU	Ambarella CV25S88
Camera Movement	Tilt: 0° to 90° Pan: 360° Rotation: 360°		

Standard video settings

Compression	H.264	Historical Video Settings	Adaptive quality ¹
Frame Rate³	24fps	Video Streaming Settings	High quality (HQ) - 1,500 Kbps Standard quality (SQ) - 300 Kbps

Standard audio settings

Audio	Not supported
--------------	---------------

Power and network

Power Input⁴	With IR: IEEE 802.3at Type 2 PoE+ Without IR: IEEE 802.3af Type 1 PoE Extended temperature range: IEEE 802.3at Type 2 PoE+	Connectivity	RJ-45 cable connector for network/PoE connection; 10/100 Mbps
Power Consumption⁴	With IR: 37-57V, 0.38-0.25A, 14W Without IR: 37-57V, 0.09-0.06A, 3.46W Extended temperature range: 37-57V, 0.61-0.37A, 22.57W	RTSP	RTSP 1.0 RFC 2326 Max concurrent streams: 2 Audio support: No

1. All our cameras record in "adaptive quality," capturing both standard and high quality streams. Standard quality (SQ) video is stored up to the amount of retention specified by the customer. The amount of high quality video stored on the camera will depend on the amount of motion detected by the camera over time. To learn more, visit our website: <https://www.verkada.com/blog/recording-in-adaptive-quality/>

2. Lens Distortion Correction (LDC) crops the sensor field of view to deliver a rectified, undistorted output image.

3. Frame rate can be adjusted by support.

4. In temperatures below -8.5°C / 16.7°F, a IEEE 802.3bt Type 3 PoE++ power source is required; even if IR is off.



Bullet Series Tech Specs



CB52-TE

General

Operating Temperature	-40°C to 50°C / -40°F to 122°F	LED Indicator	System power and status indicator
Humidity	0 to 90%	Warranty	10 Years
Certifications	FCC, ICES, CE, UKCA, RCM, VCCI, BIS, UL/IEC62368-1, IP67 weather rating, IK10 impact rating, NDAA	Included Accessories	4x M4x8 screws, 4x TP4x30 mount screws, mount plate, junction box adapter, junction box cover, T25 hand tool

Mechanical

Weight	Camera: 1478g / 52.1oz Mount plate: 33g / 1.16oz	Body	Aluminum
Dimensions	Ø: 85mm / 3.35in L: 254mm / 10in		

Software capabilities

Alerts	Camera status, motion detection, people detection, vehicle detection, Person of Interest detection, crowd detection	Streaming and Storage	Cloud backup, configurable retention days, selectable storage location, low bandwidth mode, timelapse, RTSP
People Analytics	People search, attribute search, face search, Occupancy Trends	Sharing and Privacy	Live Link, privacy regions, audit log
Vehicle Analytics	Vehicle search, attribute search	License Plate Recognition	License Plate of Interest alerts, license plate indexing



Professional video monitoring Stop Crimes in Progress

Verkada's 24/7 professional video monitoring solution enables organizations to detect and respond to threats in real time, using only cameras.



Meet your virtual guard

Professional video monitoring allows organizations to turn their Verkada cameras into a complete, monitored alarm solution - no extra hardware required. Simply select which cameras should be monitored, set an arm/disarm schedule and choose how monitoring agents should respond to a threat, such as remote talk down or notifying police.

How it works

Detect unusual activity

- Choose which cameras should be monitored and when. An alarm is triggered if a person is detected on site while the system is armed.
- Other Verkada devices, including intrusion sensors, access control, and environmental sensors, can also be configured as alarm triggers.

Assess the threat

- Monitoring agents immediately review relevant video footage to determine if there is a threat to people or property.
- Video-verification helps to ensure priority police response and screens out false alarms.

Take action

- If there is a legitimate threat, the monitoring agent will immediately notify your designated call list.
- Agents can also request emergency dispatch or talk down to intruders through an on-site speaker. Automated responses can include locking doors or turning on sirens.
- If there is no visible threat, the agent will dismiss the incident.

Key benefits



Leverage cameras as intrusion sensors



Deter intruders with remote talk down



Emergency services dispatch



More complete coverage than in person guard



No third-party contracts



Remote visibility and control

Professional monitoring of Verkada cameras is included in the LIC-BA Alarms License. One Alarms License is required for each unique site address, with no limit on monitored cameras. Professional monitoring is provided by fully redundant, US-based, UL-listed central monitoring stations with Five Diamond Certification from The Monitoring Association. Certified monitoring centers are also available in Canada and the UK.



Ordering Information

Bullet Series pricing

Model Number	MP ¹	WDR	Lens	IR Range	Onboard Storage	Maximum SQ Onboard Retention ¹	People/Vehicle Analytics	Cost (MSRP) ^{USD}
CB52-256E-HW	5.0MP	✓	Zoom	30m / 98ft	256GB	30 Days	✓	\$1,399
CB52-512E-HW	5.0MP	✓	Zoom	30m / 98ft	512GB	60 Days	✓	\$1,799
CB52-768E-HW	5.0MP	✓	Zoom	30m / 98ft	768GB	90 Days	✓	\$2,199
CB52-2TBE-HW	5.0MP	✓	Zoom	30m / 98ft	2TB	365 Days	✓	\$3,899
CB52-256TE-HW	5.0MP	✓	Zoom	50m / 164ft	256GB	30 Days	✓	\$1,499
CB52-512TE-HW	5.0MP	✓	Zoom	50m / 164ft	512GB	60 Days	✓	\$1,899
CB52-768TE-HW	5.0MP	✓	Zoom	50m / 164ft	768GB	90 Days	✓	\$2,299
CB52-2TBTE-HW	5.0MP	✓	Zoom	50m / 164ft	2TB	365 Days	✓	\$3,999

1. All our cameras record in "adaptive quality," capturing both standard and high quality streams. Standard quality (SQ) video is stored up to the amount of retention specified by the customer. The amount of high quality video stored on the camera will depend on the amount of motion detected by the camera over time. To learn more, visit our website: <https://www.verkada.com/blog/recording-in-adaptive-quality/>



Ordering Information

Video Security Cloud License pricing

Model Number	Description	Cost (MSRP) USD
LIC-1Y	1-Year Camera License	\$199
LIC-3Y	3-Year Camera License	\$549
LIC-5Y	5-Year Camera License	\$899
LIC-10Y	10-Year Camera License	\$1,799

Accessories pricing

ACC-MNT-9	Verkada Pole Mount, 2nd Generation	\$209
ACC-MNT-10	Verkada Corner Mount	\$199
ACC-MNT-11	Verkada Square Junction Box Mount	\$89
INJ-POE-PLUS	Verkada PoE Plus (802.3at) Injector, GigE	\$129

Viewing Station pricing

VX52-HW	VX52 Viewing Station	\$499
LIC-VX-1Y	1-Year Viewing Station License	\$499
LIC-VX-3Y	3-Year Viewing Station License	\$1,299
LIC-VX-5Y	5-Year Viewing Station License	\$1,999
LIC-VX-10Y	10-Year Viewing Station License	\$3,999